

RECTIFIERS

High Efficiency, 5A

UES1304
UES1305
UES1306

FEATURES

- Very Low Forward Voltage (1.15V)
- Very Fast Recovery Times (50nSec)
- Small Size
- High Surge

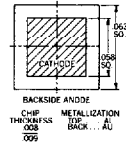

DESCRIPTION

The UES1304 series is specifically designed for operation in power switching circuits operating at frequencies of at least 20 KHz.

ABSOLUTE MAXIMUM RATINGS

Peak Inverse Voltage, UES1304200V
Peak Inverse Voltage, UES1305300V
Peak Inverse Voltage, UES1306400V
Maximum Average DC Output Current, I_O		
@ $T_A = 25^\circ\text{C}$ (Free Air)	3A
@ $T_L = 50^\circ\text{C}$, $L = \frac{1}{8}"$	5A
Surge Current, 8.3mSec70A
Thermal Resistance @ $L = \frac{1}{8}"$	20°C/W
Operating and Storage Temperature Range	-55°C to +150°C

MECHANICAL SPECIFICATIONS

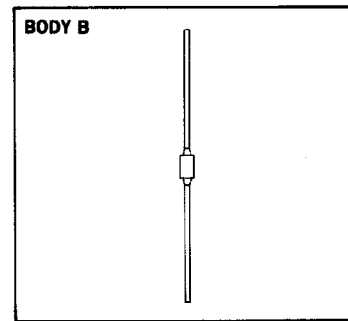
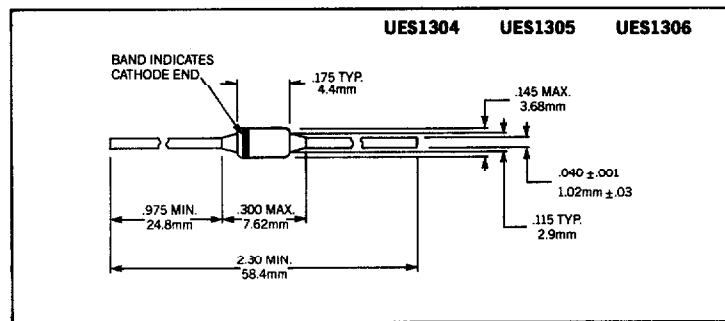

THESE DEVICES ALSO AVAILABLE IN SURFACE MOUNT PACKAGE. SEE SECTION 10

Microsemi Corp.
Watertown
The diode experts

ELECTRICAL SPECIFICATIONS

Type	PIV	Maximum Forward Voltage		Maximum Reverse Current		Maximum Reverse Recovery Time*
		$T_J = 25^\circ\text{C}$	$T_J = 100^\circ\text{C}$	@ PIV, $T_J = 25^\circ\text{C}$	$T_J = 100^\circ\text{C}$	
UES1304	200V	1.25V	1.15V	$20\mu\text{A}$	$500\mu\text{A}$	50nS
UES1305	300V	@ 3A	@ 3A			
UES1306	400V	$t_p = 300\mu\text{S}$	$t_p = 300\mu\text{S}$			

* Measured in circuit $I_F = 0.5\text{A}$, $I_R = 1\text{A}$, $I_{REC} = 0.25\text{A}$

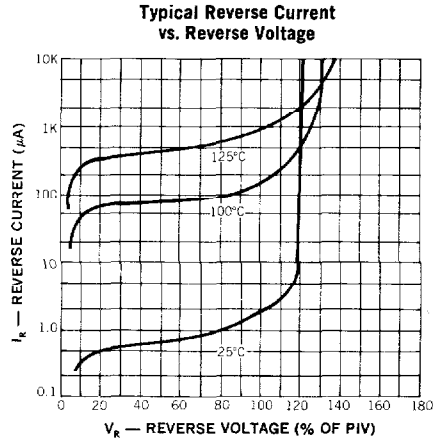
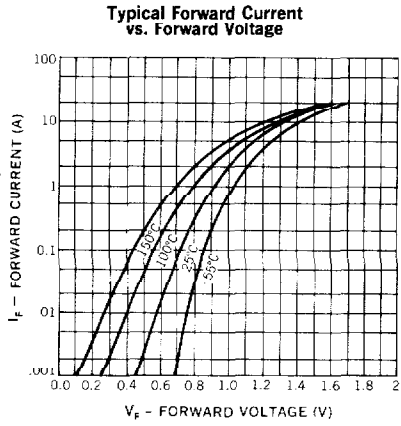
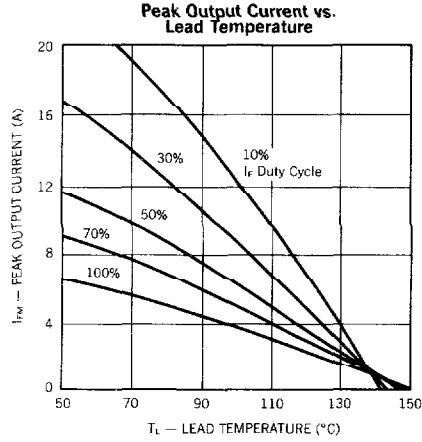
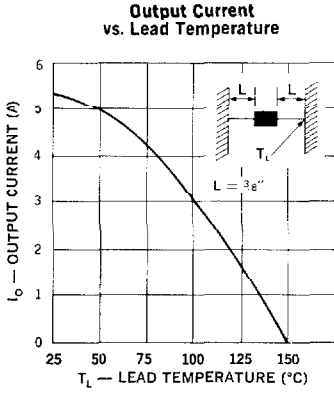

Output Current vs Ambient Temperature

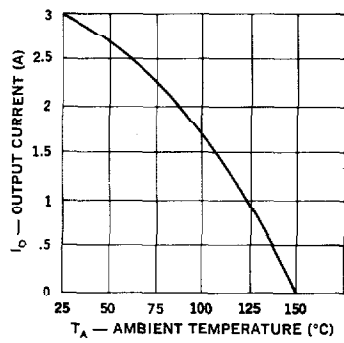

Multiple Surge Current vs. Duration

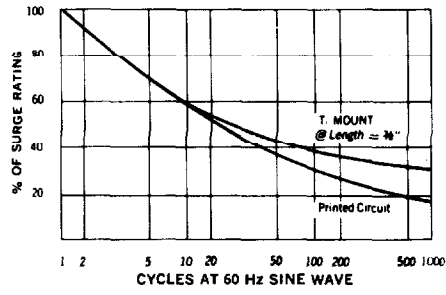

Reverse-Recovery Circuit

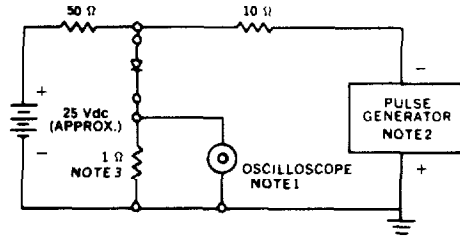

- NOTES:**
1. Oscilloscope: Rise time $\leq 3ns$; Input impedance = 50Ω .
 2. Pulse Generator: Rise time $\leq 8ns$; source impedance 10Ω .
 3. Current viewing resistor, non-inductive, coaxial recommended.